





Crimp

Crimp Terminals 52

Crimp Terminal Kits 58

Solder Sleeves 59

Contacts 60

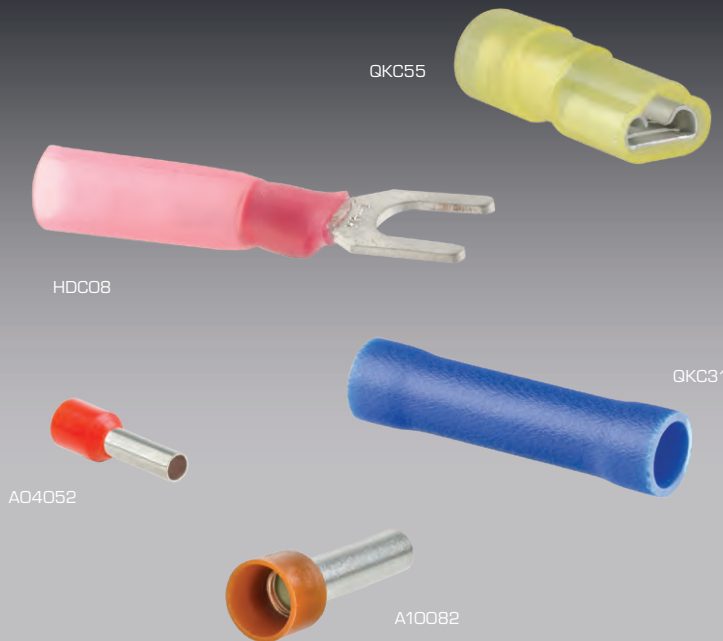

- Increased cable security with double crimp points.
- Wide range of sizes & terminal styles.
- Seamless crimp barrel.
- Colour coded for easy identification.

Crimp : Tin-plated Copper
Max. Electrical Rating : 600V @ 105°C
Pack Quantity : 100

Cable Size

All Crimp Terminals, excluding Boot Lace Ferrules, fall into 3 common cable sizes designated by the colour of the insulation :

- Red :** 0.5 – 1.5mm²
- Blue :** 1.5 – 2.5mm²
- Yellow :** 2.5 – 6mm²

Insulation Material

The insulation material of Crimp Terminals featured in this catalogue can be either Vinyl, Nylon or Heatshrink.

Vinyl

The standard insulation used on Crimp Terminals, Vinyl, provides good dielectric strength and can be used in most applications.



Nylon

A premium quality insulator, Nylon, is resistant to hydrocarbons - gasoline, hydraulic fluids and oils and has a good dielectric strength. Unlike Vinyl, Nylon does not out-gas, a critical factor in Aerospace applications.



Heatshrink

Adhesive lined heatshrink insulation has good dielectric strength and provides a hermetic seal preventing ingress of dust and water.

The combination of crimping, heatshrink and adhesive also provides a level of strain relief not achievable with standard type terminals.



Copper Double Crimp

Certain Crimp Terminals feature Copper Double Crimping, these are marked with this symbol.

















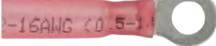



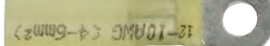



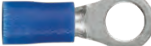











Insulation (Vinyl, Nylon or Heatshrink)

Additional tin-coated copper sleeve (double crimp)

Stamped and formed metal housing





Ring Terminals

Size	Vinyl	Nylon	Heatshrink
3mm	QKC01 		HDC01 
	QKC20 		HDC20 
4mm	QKC02 		HDC02 
	QKC21 		HDC21 
	QKC38 		HDC38 
5mm	QKC03 	NDC22 	HDC03 
	QKC22 		HDC22 
	QKC39 		HDC39 
6mm	QKC04 	NDC23 	HDC04 
	QKC23 		HDC23 
	QKC40 		HDC40 
8mm	QKC05 	NDC24 	
	QKC24 		HDC24 
	QKC41 		HDC41 
10mm	QKC06 		
	QKC25 		HDC25 
	QKC42 		HDC42 



















Crimp

Ring Terminals Continued

Size	Vinyl	Nylon	Heatshrink
12mm	QKC26 		
	QKC43 		HDC43 

Fork / Spade Terminals















Size	Vinyl	Nylon	Heatshrink
3mm	QKC07 		HDC07 
	QKC27 		HDC27 
4mm	QKC08 		HDC08 
	QKC28 		HDC28 
	QKC45 		
5mm	QKC09 		HDC09 
	QKC29 		HDC29 
	QKC46 		HDC46 
6mm	QKC47 		HDC47 

Butt Splices









	Vinyl	Nylon	Heatshrink
QKC11		NDC11 	HDC11 * 
QKC31		NDC31 	HDC31 * 
QKC49			HDC49 * 

* HDC11 & HDC31 are also available in packs of 1000. HDC49 is also available in packs of 500.

Blade Terminals – Fully Insulated – Female

Size	Vinyl	Nylon	Heatshrink
4.8mm	QKC66  Double Crimp		
	QKC67  Double Crimp		
6.3mm	QKC73  Double Crimp	QKC16  Double Crimp	HDC16 
	QKC74  Double Crimp	QKC35  Double Crimp	HDC35 
	QKC75  Double Crimp	QKC55  Double Crimp	HDC55 
Flag 6.3mm		QKC77  Double Crimp	QKC78 
9.4mm	QKC53  Double Crimp		

Blade Terminals – Female

Size	Vinyl	Heatshrink
2.8mm	QKC19  Double Crimp	
5.2mm	QKC13  Double Crimp	
6.3mm	QKC12  Double Crimp	HDC12 
	QKC32  Double Crimp	HDC32 
9.4mm	QKC50  Double Crimp	HDC50 
	QKC51  Double Crimp	

Pin Terminals

Size	Vinyl
2mm x 10mm	QKC10  Double Crimp
2mm x 12mm	QKC30  Double Crimp
2.6mm x 14mm	QKC48  Double Crimp

Flat Blade Terminals

Size	Vinyl
2.3mm x 10mm	QKC63  Double Crimp
2.4mm x 13mm	QKC71  Double Crimp





Piggyback / Adaptor Terminals

Size	Vinyl	Vinyl	Non-Insulated
6.3mm	QKC15  Double Crimp	QKC34  Double Crimp	QKC54 









Crimp





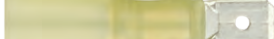

Blade Terminals – Fully Insulated – Male

Size	Vinyl	Nylon	Heatshrink
6.3mm		NDC64  Double Crimp	HDC64 
		NDC65  Double Crimp	HDC65 
			HDC68 





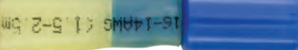

Blade Terminals – Male

Size	Vinyl	Nylon	Heatshrink
2.8mm	QKC68  Double Crimp		
6.3mm	QKC14  Double Crimp		HDC14 
	QKC33  Double Crimp		HDC33 
	QKC87  Double Crimp		HDC87 

Bullet Terminals – Female

Size	Vinyl	Nylon	Heatshrink
4mm	QKC18  Double Crimp	NDC18  Double Crimp	
5mm	QKC37  Double Crimp	NDC37  Double Crimp	HDC37 
	QKC57  Double Crimp		

Bullet Terminals – Male

Size	Vinyl	Nylon	Heatshrink
4mm	QKC17  Double Crimp	NDC17  Double Crimp	
5mm	QKC36  Double Crimp	NDC36  Double Crimp	HDC36 
	QKC56  Double Crimp		

End Sleeve Boot Lace Ferrules

Part No.	Cable Size (mm ²)	Colour	Length (mm)	
A00552/100	0.50	White	8	
A00752/100	0.75	Blue	8	
A01052/100	1	Red	8	
A01552/100	1.5	Black	8	
A02552/100	2.5	Grey	8	
A04052/100	4	Orange	9	
A06052/100	6	Green	12	
A10082/100	10	Brown	18	



HT-0060



HT-0560



HT-0580

Crimp Terminals – Crimpers

Part No.	Description	Crimp Range
HT-0060	Ratcheting. Suiting Insulated Flag Terminals	Red & Blue
HT-0560	Ratcheting	Red, Blue & Yellow
HT-0580	Ratcheting crimper for End Sleeve Boot Lace Ferrules. Range – 0.25–6mm ²	





- Convenient on site service kits containing assortments of crimp terminals.
- Contents clearly illustrated.
- Seamless crimp barrel.
- Colour coded terminals for easy identification.
- QKC-KIT box features individually removable compartments.
- 1200KIT supplied in an Australian made Rola-Case®.

Crimp : Tin-plated Copper
 Insulation : Vinyl
 Max. Electrical Rating : 600V @ 105°C



Crimp Terminal Assortment Kits

Part No.	Description	Kits Contain:
1200KIT	1200 piece Rola-Case®	<p>Cable Size 0.5 - 1.5mm²:</p> <ul style="list-style-type: none"> 50 x QK003 Ring Terminal 50 x QK004 Ring Terminal 50 x QKC11 Butt Splice 50 x QKC14 Blade Terminal Male 50 x QKC16 Blade Terminal Female <p>Cable Size 1.5 - 2.5mm²:</p> <ul style="list-style-type: none"> 100 x QKC22 Ring Terminal 50 x QKC23 Ring Terminal 50 x QKC24 Ring Terminal 100 x QKC31 Butt Splice 50 x QKC33 Blade Terminal Male 50 x QKC34 Blade Piggyback Terminal 100 x QKC35 Blade Terminal Female 50 x QKC36 Bullet Terminal Male 50 x QKC37 Bullet Terminal Female <p>Cable Size 2.5 - 6mm²:</p> <ul style="list-style-type: none"> 50 x QKC40 Ring Terminal 50 x QKC41 Ring Terminal 50 x QKC42 Ring Terminal 50 x QKC49 Butt Splice 100 x QKC55 Blade Terminal Female 50 x QKC87 Blade Terminal Male
QKC-KIT	625 piece	<p>Cable Size 0.5 - 1.5mm²:</p> <ul style="list-style-type: none"> 25 x QK002 Ring Terminal 25 x QK004 Ring Terminal 25 x QK005 Ring Terminal 50 x QKC11 Butt Splice 25 x QKC14 Blade Terminal Male 50 x QKC16 Blade Terminal Female <p>Cable Size 1.5 - 2.5mm²:</p> <ul style="list-style-type: none"> 25 x QKC22 Ring Terminal 25 x QKC23 Ring Terminal 25 x QKC24 Ring Terminal 50 x QKC31 Butt Splice 25 x QKC33 Blade Terminal Male 50 x QKC35 Blade Terminal Female <p>Cable Size 2.5 - 6mm²:</p> <ul style="list-style-type: none"> 25 x QKC39 Ring Terminal 25 x QKC40 Ring Terminal 25 x QKC41 Ring Terminal 25 x QKC42 Ring Terminal 50 x QKC49 Butt Splice 50 x QKC55 Blade Terminal Female 25 x QKC87 Blade Terminal Male

- Adheres and solders cables in one action.
- Heat shrink tubing.
- Simple, easy, secure.
- Environmentally sealing.

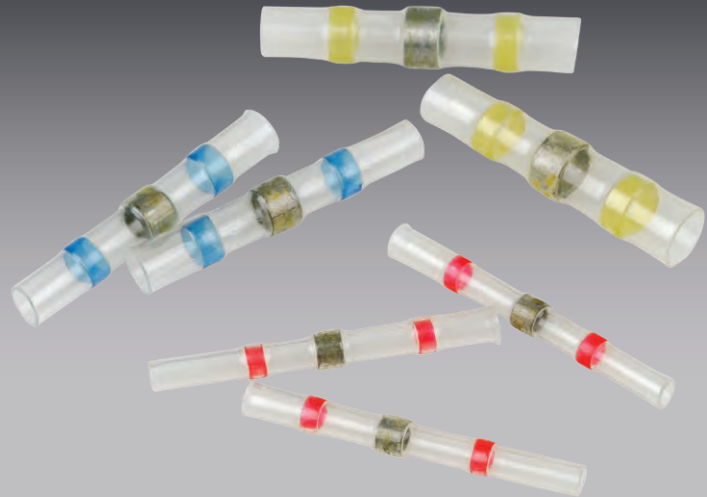

Shrink Ratio : 2:1
 Shrink Temperature : 60°C
 Solder Melt Temperature : 115°C
 Operating Temperature : -55°C to 105°C

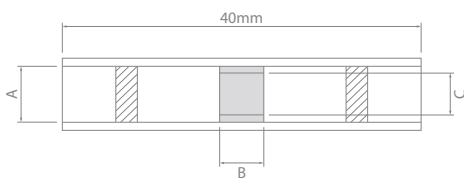
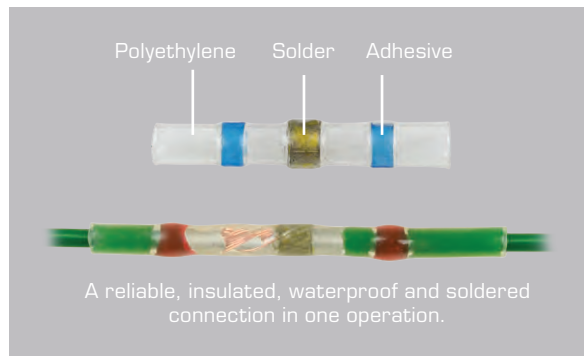

Solder Sleeves

Pack Qty - 10	Colour	Cable Size (mm ²)	A (mm)	B (mm)	C (mm)
SSJ11/10	Red	0.5 - 1.0	4.4	3.2	2.8
SSJ31/10	Blue	1.5 - 2.5	6.5	4.2	4.8
SSJ49/10	Yellow	4.0 - 6.0	7.8	4.2	6.2



- Wide range of high quality stamped and formed non-insulated contacts.

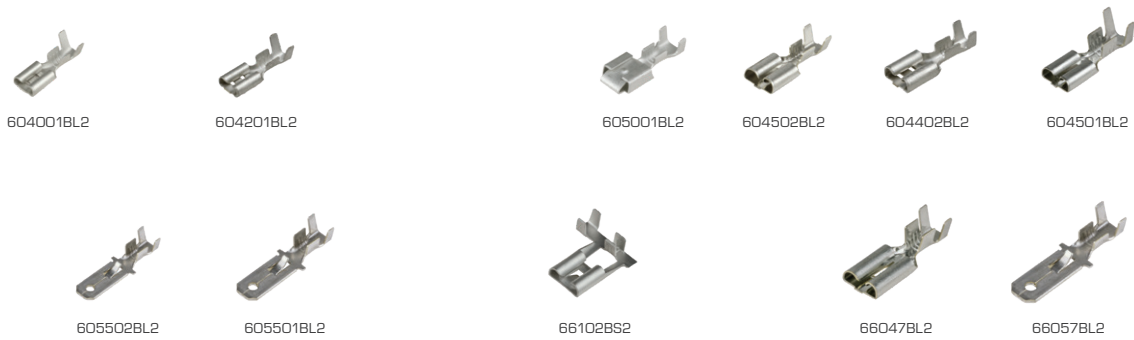
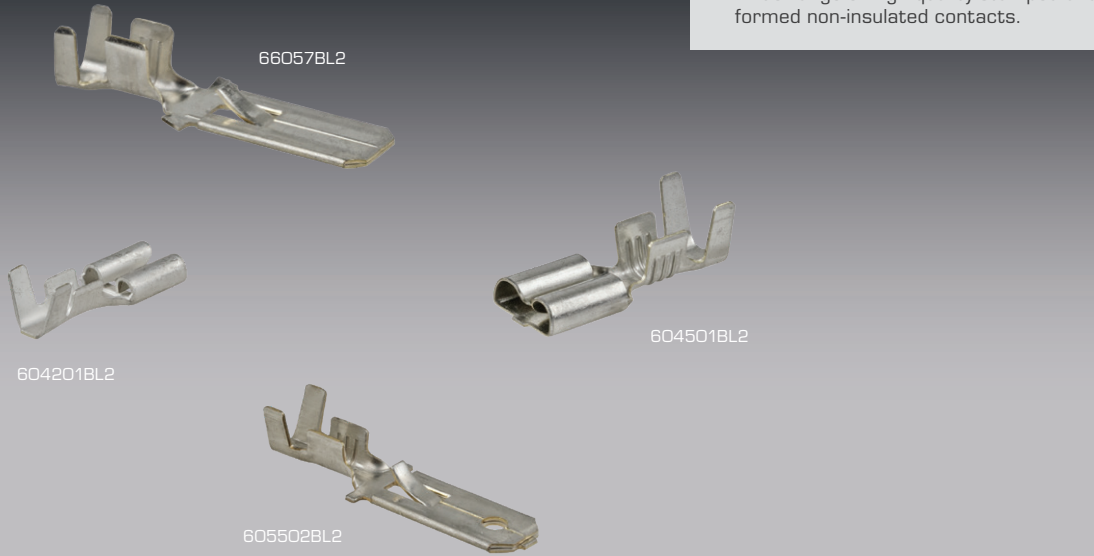

Contacts

Part No.	Pack Qty	Type	Blade Size (mm)	Wire Size (mm ²)	Locking Tab	Material
604001BL2/100	100	Receptacle	2.8	0.85 – 1.3	No	Tin-plated brass
604201BL2/100	100	Receptacle	4.8	0.85 – 1.3	No	Tin-plated brass
605001BL2/100	100	Receptacle	6.3	1.0 – 1.5	Yes	Tin-plated brass
604502BL2/100	100	Receptacle	6.3	1.0 – 2.0	Yes	Tin-plated brass
604402BL2/100	100	Receptacle	6.3	1.0 – 2.0	No	Tin-plated brass
604501BL2/100	100	Receptacle	6.3	2.0 – 3.0	Yes	Tin-plated brass
605502BL2/100	100	Tab	6.3	1.5 – 2.0	Yes	Tin-plated brass
605501BL2/100	100	Tab	6.3	2.0 – 3.0	Yes	Tin-plated brass
66102BS2/100	100	Receptacle	6.3	1.0 – 3.0	No	Tin-plated brass
66047BL2/100	100	Receptacle	8	3.0 – 5.0	Yes	Tin-plated brass
66057BL2/100	100	Tab	8	3.0 – 5.0	Yes	Tin-plated brass



281197-2



42241-1



42282-2



280756-4

Contacts – TE Faston

Pack Qty – 100	Type	Blade Size (mm)	Wire Size (mm ²)	Locking Tab	Material
281197-2/100	Receptacle	4.8	1.0 – 2.5	Yes	Tin-plated phosphor bronze
42241-1/100	Tab	6.3	0.8 – 2.0	Yes	Brass (unplated)
42282-2/100	Receptacle	6.3	0.8 – 2.0	Yes	Tin-plated brass
280756-4/100	Receptacle	9.5	3.0 – 6.0	Yes	Tin-plated phosphor bronze



1241389-1



1241391-1

Contacts – TE MCP NEW

Pack Qty – 100	Pack Qty – Reel	Reel Qty	Type	Blade Size (mm)	Wire Size (mm ²)	Cable O.D. Range (mm)	Locking Tab
1241389-1/100	1241388-1-BULK	3500	Receptacle	2.8	0.5 – 1.0	1.4 – 2.1	Yes
1241391-1/100	1241390-1-BULK	3500	Receptacle	2.8	1.0 – 2.5	2.3 – 3.0	Yes

Material – Tin-plated copper alloy

Fits 2016 Toyota Hilux factory accessory fuse box. Also suits Komatsu and others.



1241395-1,
968875-1



1241397-1,
968876-1



1241415-1



1241417-1

Single Wire Sealing System

Contacts crimp directly to seals



Seals found on page 35

Contacts – TE MCP – Single Wire Sealing System NEW

Pack Qty – 100	Pack Qty – Reel	Reel Qty	Type	Blade Size (mm)	Wire Size (mm ²)	Locking Tab
1241395-1/100	1241394-1-BULK	3500	Receptacle	2.8	0.5 – 1.0	Yes
968875-1/100	—	—	Receptacle	2.8	0.5 – 1.0	Yes
1241397-1/100	1241396-1-BULK	3500	Receptacle	2.8	1.0 – 2.5	Yes
968876-1/100	—	—	Receptacle	2.8	1.0 – 2.5	Yes
1241415-1/100	1241414-1-BULK	1500	Receptacle	4.8 & 6.3	1.0 – 2.5	Yes
1241417-1/50	1241416-1-BULK	1500	Receptacle	4.8 & 6.3	2.5 – 4.0	Yes

Material – Tin-plated copper alloy



Crimp



927779-3



925590-2



925575-1

Contacts – TE Timers

Part No.	Type	Pack Qty	Blade Size (mm)	Wire Size (mm ²)	Cable O.D. Range (mm)	Locking Tab	Description
927779-3/100	Receptacle	100	2.8	0.5 – 1.0	1.4 – 2.3	Yes	AMP/TE. Junior Timer Contact
925590-2/10	Receptacle	10	2.8	1.5 – 2.5	2.0 – 3.0	Yes	AMP/TE. Junior Timer Contact
925575-1/100	Receptacle	100	4.8 & 6.3	0.5 – 1.0	2.0 – 3.0	Yes	AMP/TE. Standard Timer Contact

Material – Tin-plated copper alloy

NEW



604402VL

Contacts – Accessory NEW

Pack Qty – 100	Description
604402VL/100	Contact insulator suit 6.3mm receptacles

NEW



P-12020321

NEW



P-12020400

NEW



P-12004568

Contacts – Pack-Con III NEW

Part No.	Pack Qty	Type	Blade Size (mm)	Wire Size (mm ²)	Cable O.D. Range (mm)	Locking Tab	Material
P-12020321/100	100	Receptacle	5	1.0 – 2.0	2.55 – 3.95	Yes	Brass (unplated)
P-12020400	1	Receptacle	5	3.0 – 5.5	5.1 – 3.55	Yes	Brass (unplated)
P-12004568	1	Receptacle (4x bussed)	5	3.0 – 5.0	5.1 – 3.55	Yes	Brass (unplated)

NEW



UBM/100

NEW



UBM-INS/100

NEW



UBFM/100

NEW



UBFM-INS/100



Bullet Terminals – Non-Insulated NEW

Pack Qty – 100	Gender	Insulator (Pack Qty – 100)
UBM/100	Male	UBM-INS/100
UBFM/100	Female	UBFM-INS/100



Wire Splice NEW

Pack Qty - 100	Wire Size (mm ²)	Description	Material
6608002BS/100	0.8 - 2.0	11mm length	Brass (unplated)



Double hinged for parallel crimping



HT-4220

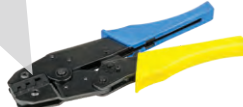

HT-4560

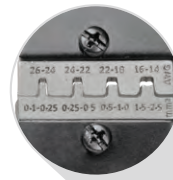

HT-4305



NEW



HT-4307



NEW



HT-4308

Contacts - Tools

Part No.	Description	Sizes
HT-4220	Crimp tool. Parallel crimping	0.2-0.3, 0.3-0.5, 0.5-0.8, 0.8-1.3, 1.3-2.0mm ²
HT-4560	Crimp tool. Ratcheting	0.5-1, 1.5-2.5, 4-6
HT-4305 NEW	Crimp tool. Ratcheting. Suits Wire Splice	0.1-0.25mm ² , 0.25-0.5mm ² , 0.5-1.0mm ² , 1.5-2.5mm ² 26-24 AWG, 24-22 AWG, 22-18 AWG, 16-14 AWG
HT-4307 NEW	Contact removal tool. Suits TE MCP 2.8mm Series	
HT-4308 NEW	Contact removal tool. Suits TE MCP 4.8mm & 6.3mm Series	

